

# ➤ Instructions

## Thule FreeRide 532



**EN** Roof-mounted bike carrier  
**DE** Dachfahrradträger  
**FR** Porte-vélo sur le toit  
**NL** Fietsdrager voor op het dak  
**IT** Portabici da installare sul tetto  
**ES** Portabicicletas de techo  
**PT** Suporte para bicicleta para teto  
**SV** Takmonterad cykelhållare  
**DK** Tagmonteret cykelholder  
**NO** Takmonterte lasteholdere  
**FI** Katolle asennettava polkupyöräteline  
**ET** Katusele paigaldatav jalgrattahoidik  
**LV** Uz jumta uzstādāms velosipēdu turētājs  
**LT** Ant stogo tvirtinami dviračių laikikliai  
**PL** Bagażnik rowerowy montowany na dachu  
**RU** Устанавливаемое на крыше крепление для велосипедов  
**UK** Багажник для велосипедів, що монтується на даху  
**BG** Покривен багажник за велосипеди  
**CS** Nosič jízdních kol s montáží na střechu  
**SK** Nosič bicyklov s montážou na strechu  
**SL** Nosilec za kolesa  
**HR/BIH** Krovni nosač bicikla

**RO** Suport pentru bicicletă montat pe pavilion  
**HU** Tetőre szerelhető kerékpártartó  
**EL** Σχάρα ποδηλάτου οροφής  
**TR** Araç üstüne bağlanan bisiklet taşıyıcı  
**ZH** 頂置自行車架  
**JA** ルーフマウント型サイクルキャリア  
**KO** 지붕 장착 자전거 캐리어  
**TH** โครงยึดจัดจักรยานแบบติดตั้งบนหลังคา

**HE** מנשא אופניים המורכב על המכוון  
**AR** حامل الدراجة للتثبيت على السقف

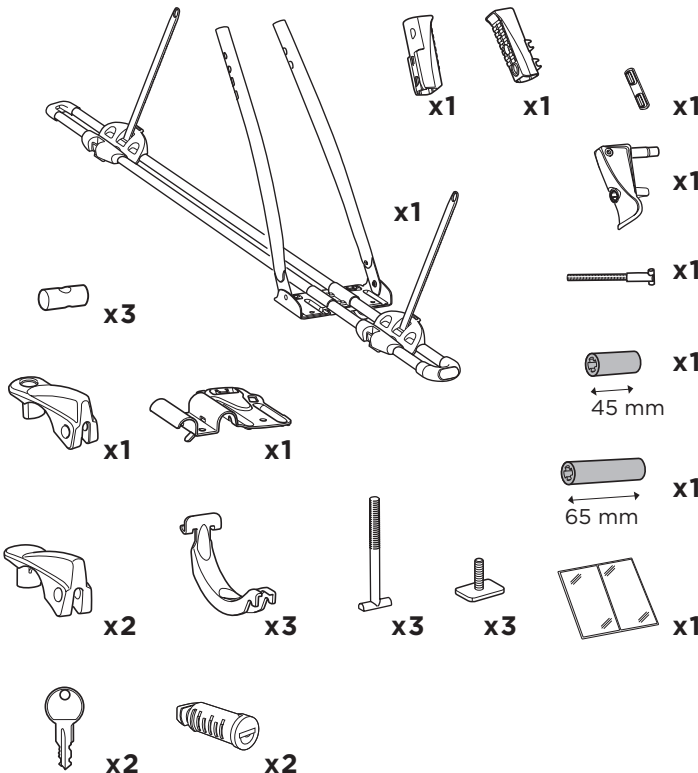
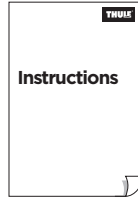

**i**

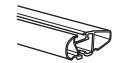

Thule WingBar

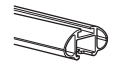

Thule AeroBar

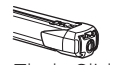

Thule SlideBar

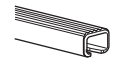

Thule SquareBar

**i**

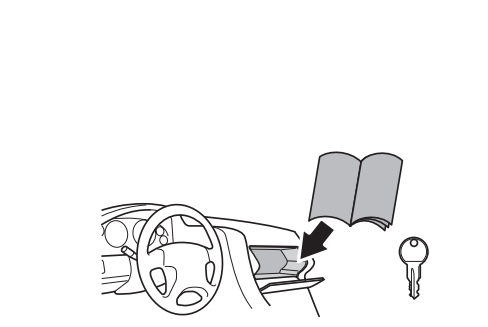
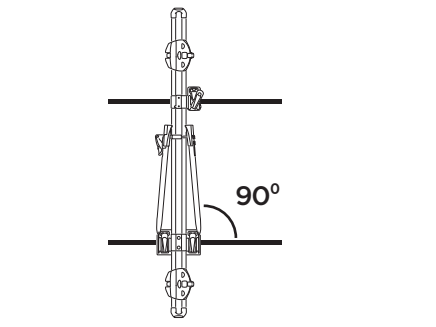
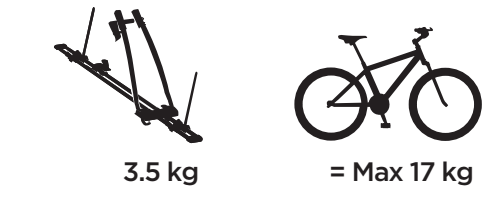
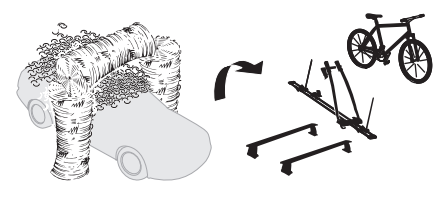
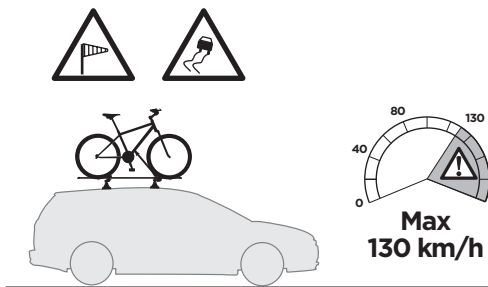
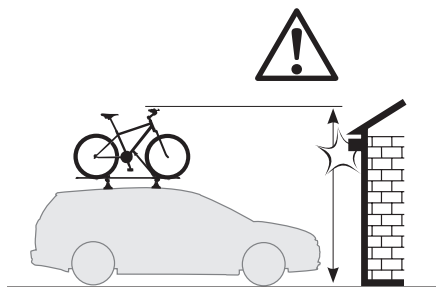

1

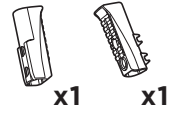
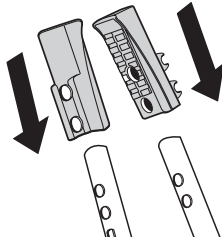

2

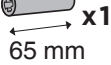
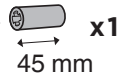

$\varnothing 22 - 58 \text{ mm}$

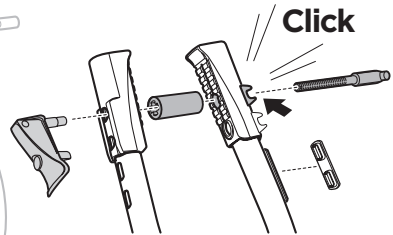
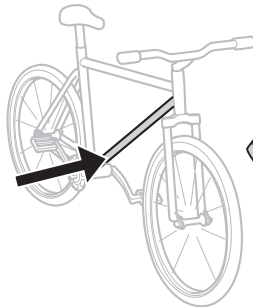

$\varnothing 59 - 70 \text{ mm}$   
 Max  
 65 x 80 mm

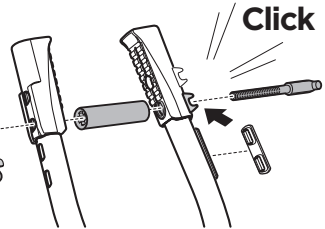
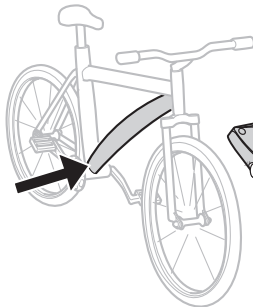

**3**

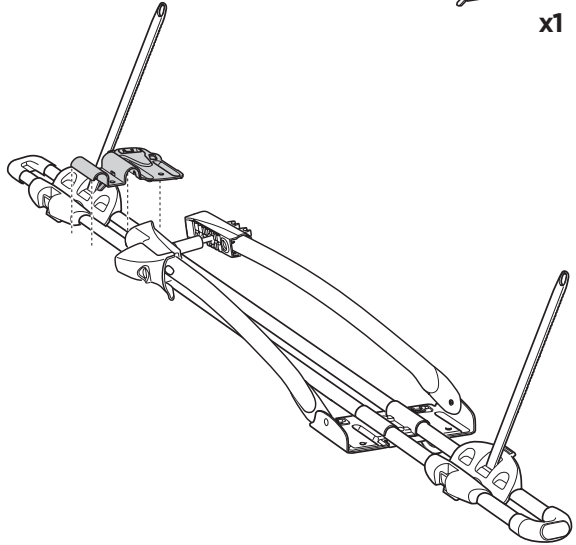
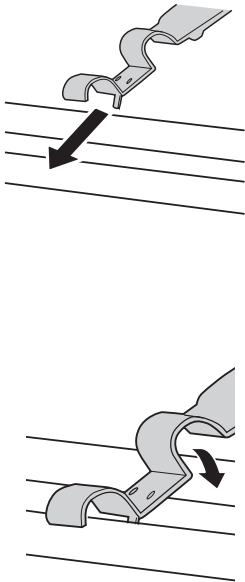

**4**

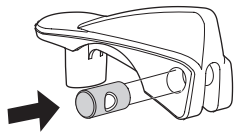
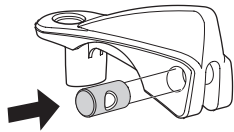

5

**i**

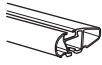

Thule WingBar

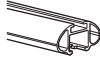

Thule AeroBar



Thule SlideBar



x1



x3

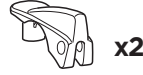

x2

**A**

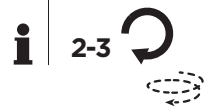
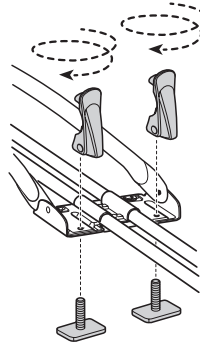
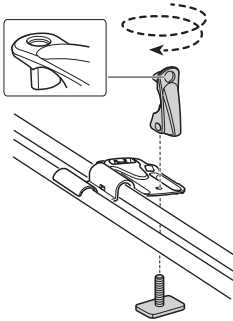

**B**

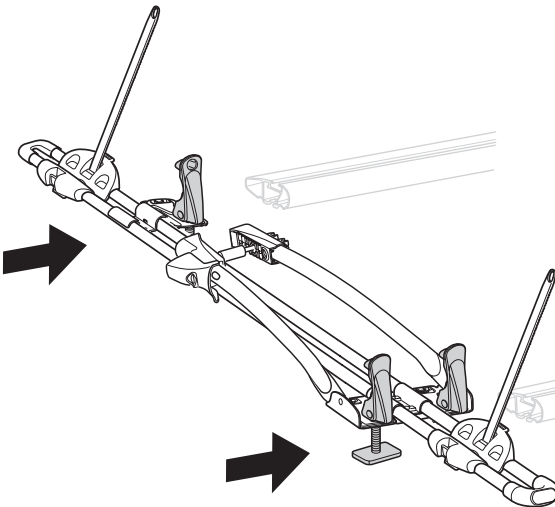

**C**

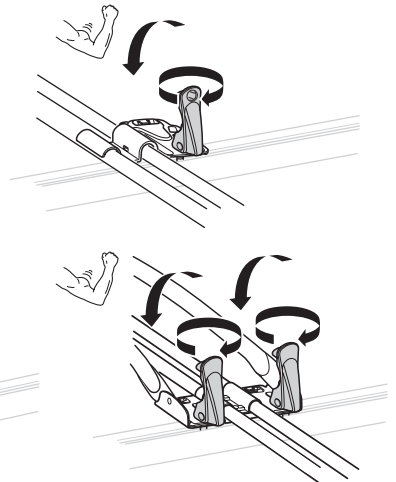

5

i

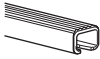

Thule SquareBar



x1



x3



x2



x3

A

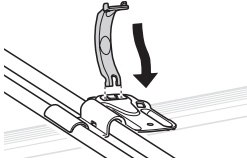

B

i 2-3

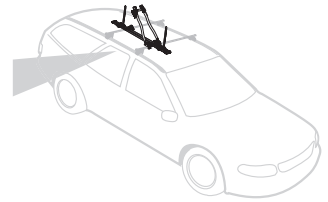
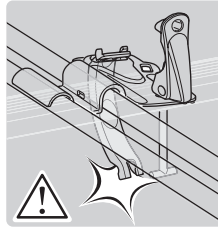
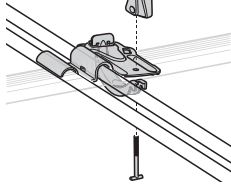

C

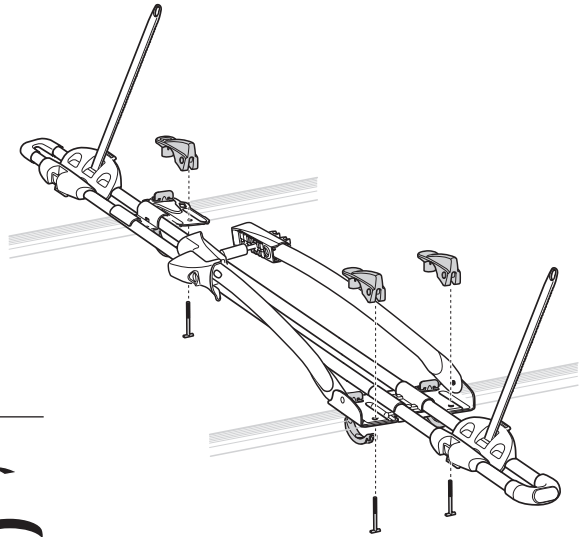
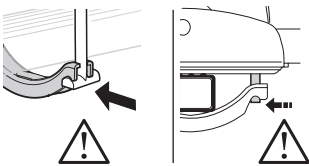

D

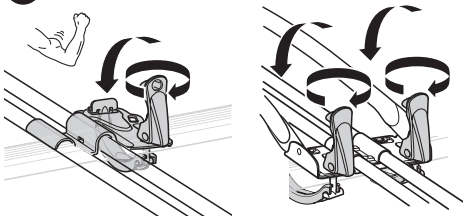

6

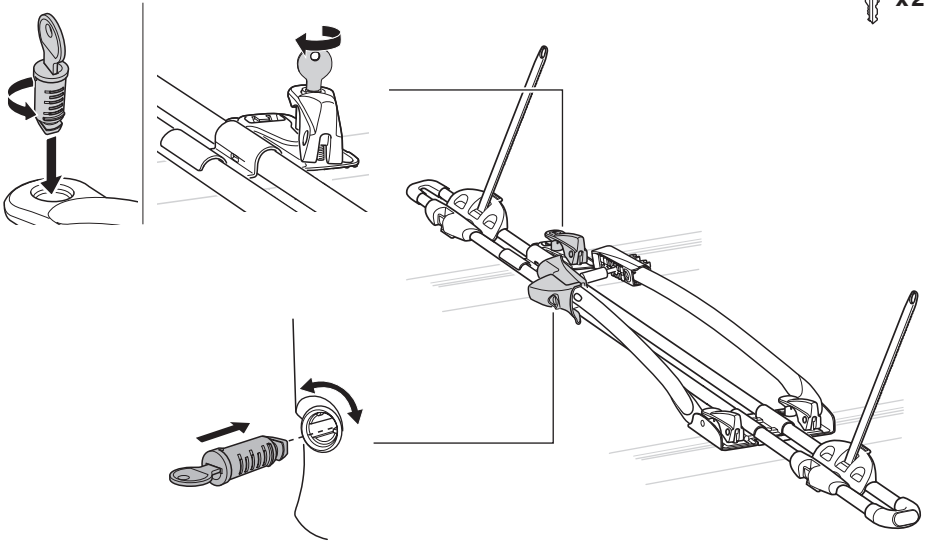

7

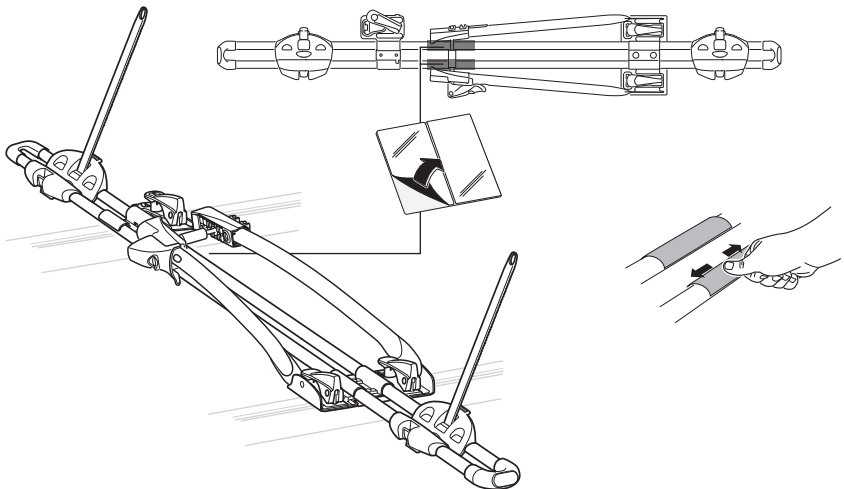
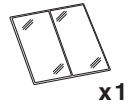



8

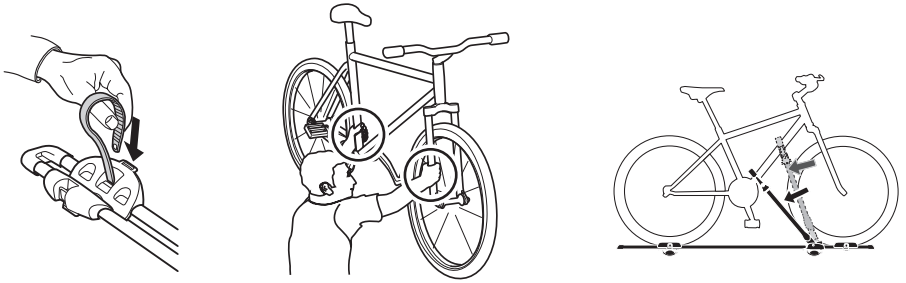

9

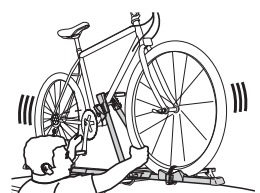
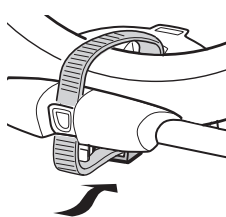
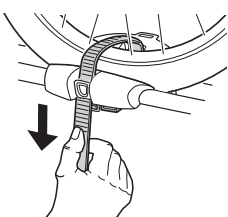
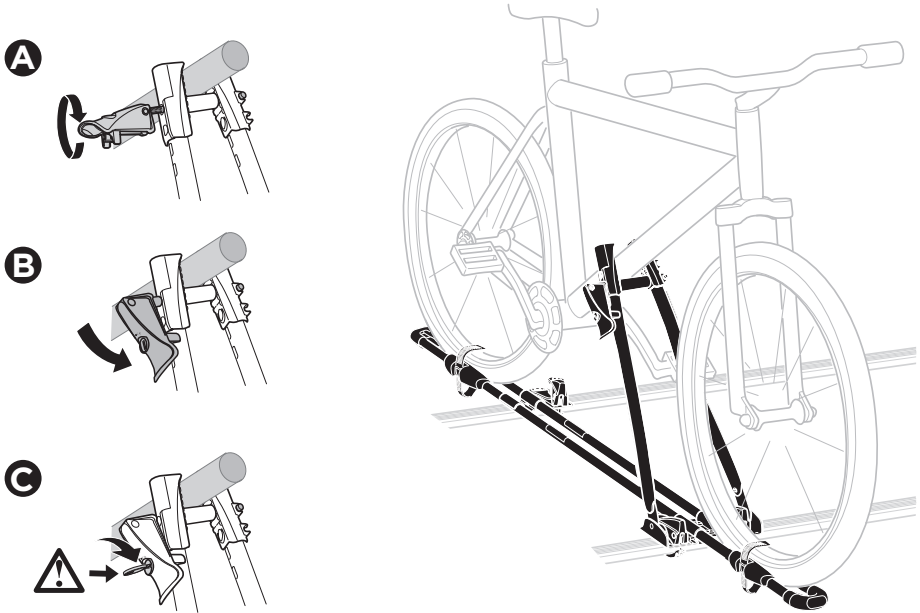

<b>EN</b>	Left-hand fitting	<b>UK</b>	Установка на ліву сторону		
<b>DE</b>	Montage links	<b>BG</b>	Монтаж отляво		
<b>FR</b>	Montage côté gauche	<b>CS</b>	Montáž z levé strany		
<b>NL</b>	Montage aan de linker kant	<b>SK</b>	Montáž na ľavej strane		
<b>IT</b>	Montaggio a sinistra	<b>SL</b>	Pritrjevanje z leve strani		
<b>ES</b>	Montaje a izquierda	<b>HR/BIH</b>	Montaža s lijeve strane		
<b>PT</b>	Montagem do lado esquerdo	<b>RO</b>	Montare pe partea stângă		
<b>SV</b>	Vänstermonterad	<b>HU</b>	Bal oldalról szerelhető		
<b>DK</b>	Venstremontering	<b>EL</b>	Τοποθέτηση αριστερά		
<b>NO</b>	Venstremontering	<b>TR</b>	Sol elle montaj		
<b>FI</b>	Asennus vasemmalle			התקנה שמאלית	<b>HE</b>
<b>ET</b>	Vasakpoolne kinnitamine			التركيب في الجانب الأيسر	<b>AR</b>
<b>LV</b>	Kreisais stiprinājums	<b>ZH</b>	从左侧安装		
<b>LT</b>	Kairysis pritvirtinimas	<b>JA</b>	左手装着		
<b>PL</b>	Montaż z lewej	<b>KO</b>	왼손 장착		
<b>RU</b>	Установка на левую сторону	<b>TH</b>	ตัวยึดด้านซ้ายมือ		

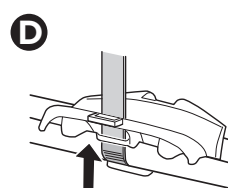
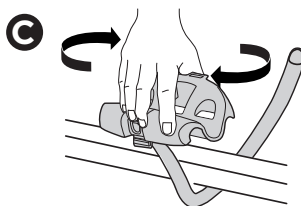
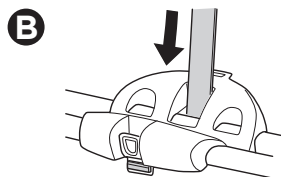
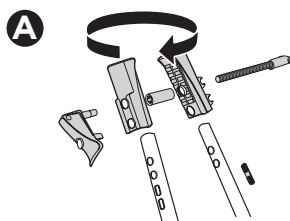
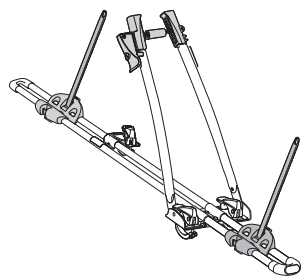



<b>EN</b> Accessories	<b>DK</b> Tilbehør	<b>UK</b> Аксессуары	<b>EL</b> Εξαρτήματα
<b>DE</b> Zubehör	<b>NE</b> Tilbehør	<b>BG</b> Принадлежности	<b>TR</b> Aksesuarlar
<b>FR</b> Accessoires	<b>FI</b> Lisävarusteet	<b>CS</b> Doplòky	<b>AR</b> الملحقات
<b>NL</b> Accessoires	<b>ET</b> Lisavarustus	<b>SK</b> Príslušenstvo	<b>HE</b> אביזרים
<b>IT</b> Accessori	<b>LV</b> Piederumi	<b>SL</b> Dodatki	<b>ZH</b> 附件
<b>ES</b> Accesorios	<b>LT</b> Priedai	<b>HR/BiH</b> Dodaci	<b>JA</b> アクセサリー
<b>PT</b> Acessórios	<b>PL</b> Akcesoria	<b>RO</b> Accesorii	<b>KO</b> 액세서리
<b>SV</b> Tillbehör	<b>RU</b> Аксессуары	<b>HU</b> Tartozékok	<b>TH</b> อุปกรณ์เสริม

## Thule One-Key System

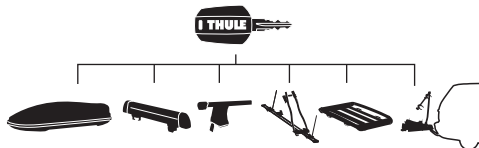

- 544**  (x4)
- 596**  (x6)
- 588**  (x8)
- 452**  (x12)

## Thule Adapter 889-3

